

# Accuphase

## C-240

PRECISION CONTROL CENTER



The C-240 is a high-gain, Control Center Amplifier which symbolizes the combined aggregation of Accuphase audio technology. It has a total gain of 86dB and includes a Head Amplifier for Moving coil cartridges and a full-fledged Headphone Amplifier.

Besides providing all the standard functions of the most versatile Control Center, the C-240 has wide ranging frequency response control capability which is truly outstanding. This important feature not only permits the most delicate tonal adjustments to satisfy individual tastes, but even allows alteration of phono cartridge characteristics for improved fidelity.

The basic circuitry consists of the complementary-symmetry, Class-A push-pull driven DC amplifier circuits in every stage, which is an Accuphase original. Only the highest rank active devices available are used wherever they may affect sound quality, and newly developed devices have been introduced where necessary.

The panel layout which is dotted with Push Switch Buttons is indeed unique as the photo shows. In fact, it is completely different from ordinary Control Center front panels, and operation may seem complicated at first glance to the uninitiated. However, the exact opposite is true for operational ease was the main factor in designing this new panel function face which represents another significant advance in human engineering. Actual operation proves this immediately as anyone will realize that the direct, speedy control of push-button switches cannot be duplicated with rotary switches.

## 1 UNIQUE FRONT PANEL

This unique front panel is composed of four rotary knobs, one lever switch and, indeed, a total of 57 push switches. However, there is no feeling of complexity since they are arranged in a most orderly manner according to function, as planned in initial design. Rather, the feeling of instantaneous fingertip control that cannot be experienced with rotary switches becomes immediately apparent since unnecessary positions can be jumped, and necessary function positions set immediately.

This is especially the case with input selector buttons. They provide "feather touch" input source selection electronically by activating electronic circuits which control the relays.

The advantage of electronic control is also utilized for Head Amplifier switching which is linked with DISC 1 and DISC 2 cartridge selection with a memory feature that automatically handles respective ON/OFF switching.

Also parallel dual contact points are built into all push switches and relays in order to minimize contact resistance which can greatly affect sound quality and durability. This extravagant measure further ensures highest stability and long life performance.

## 2 COMPLEMENTARY-SYMMETRY, CLASS-A PUSH-PULL DRIVEN, ICL TYPE, DC AMPLIFIER CIRCUITS IN EVERY STAGE

The Accuphase C-240 employs the extravagant complementary-symmetry, Class-A push-pull driven DC amplifier circuits all the way from the Head Amplifier input to the final output, including the headphone amplifier. Although this system requires almost twice as many parts as ordinary circuits, it possesses superior open-loop characteristics, including especially excellent linearity. Therefore, it requires a minimum of NFB application and accounts for its outstanding low distortion ratio. As a result, great improvement was made in

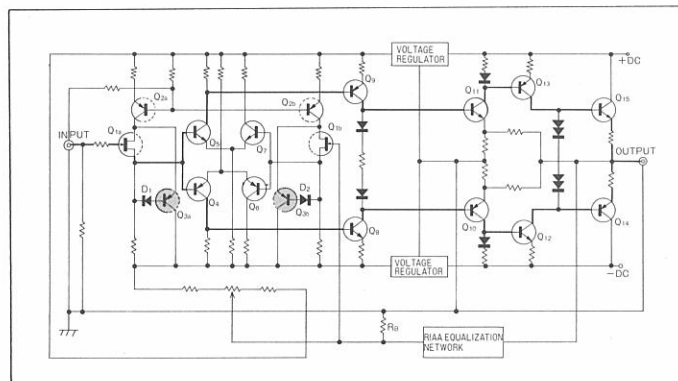

Fig. 1. DIAGRAM OF EQUALIZER AMPLIFIER

preventing TIM (Transient Intermodulation Distortion) which causes sound quality deterioration.

All unit amplifiers are pure DC amps. High capacity DC blocking capacitors have been completely eliminated from the NF loops, as well as all input coupling capacitors. (ICL system: Input Capacitor-Less). The removal of these capacitors has eliminated the possibility of sound coloration. During phono reproduction, the cartridge is directly connected to the amplifier and this permits enjoyment of a higher quality disc reproduction sound.

## 3 DYNAMIC RANGE, LOW-NOISE, MODULAR-TYPE HEAD AMPLIFIER

The Head Amplifier is a 26dB gain flat amplifier. Four RETs (Ring Emitter Transistor) that were especially developed to handle low level input signals are employed in the first stage push-pull differential amplifier circuit. Their use has contributed greatly to the head amplifier's low noise characteristic. Moreover, the large current used to drive the output stage has made it possible to lower both the output and feedback loop impedances, which are additional reasons for the high S/N ratio of 74dB, a value that is close to the theoretical limit.

Clipping in Control Amplifiers can seriously deteriorate sound quality. In order to provide sufficient dynamic margin for 0.5mV cl cartridges without danger of clipping, the C-240 is designed to handle maximum input voltage of 20mV without clipping. Input impedance is a fixed 100 ohms when the head amplifier is used.

The head amplifier block is encased in a module to prevent moisture penetration and assure stable operation against any possible humidity conditions.

## 4 HIGH S/N EQUALIZER AMP COMPLETELY PREVENTS SOUND COLORATION

Figure 1 shows the 36dB equalizer amplifier section of this unit. Following the input FET buffer amplifier, it is comprised of complementary-symmetry, push-pull amplifier circuits in every stage. RETs are used for Q14 and Q15 at the equalizer output for superior high frequency power amplification. A very high S/N ratio of 86dB, which is close to the theoretical limit is achieved because of the low output impedance and low feedback loop impedance made possible by the large driving current of class-A operation. Another contributing factor is the high forward transconductance of the FETs (High Gm FETs) in the input buffer amplifier. The equalizer amplifier is equipped with a Cgd (gate-to-drain capacitance) Cancelling Circuit to prevent high frequency distortion that can be caused by Gate-to-Drain capacitance of Q1 in the buffer amp section. It is the usual practice as a prevention measure to use a cancelling capacitor between Gate and Source, but it can cause sound coloration since this input circuit deals with phono cartridges that contain reactance components. The Cgd Cancelling Circuit built around Q3a, Q3b, D1 and D2 very effectively prevents high frequency distortion and sound coloration.

## 5 DC SERVO CONTROL HIGH-LEVEL AMPLIFIER

It is customary in high-level amplifiers to adjust tone by varying the capacitance and resistance of the NF device. In such cases, a small DC current is created in the amplifier output which can cause a large pulse type shock noise. A DC blocking capacitor is normally used to prevent

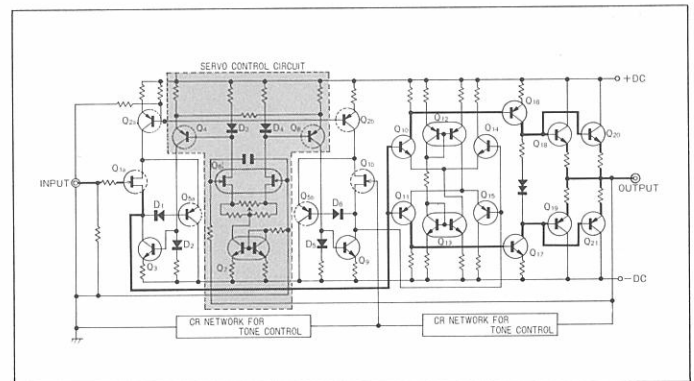

Fig. 2. DIAGRAM OF SERVO CONTROLLED HIGH-LEVEL AMPLIFIER

# Accuphase C-240

PRECISION CONTROL CENTER

this, but such an amplifier cannot function as a DC amplifier. The DC blocking capacitor can also cause sound coloration.

A DC Servo Control System (Pat. Pend.) permits the C-240 to operate as a pure DC amplifier even when the tone control is used, since it can effectively hold DC drift to practically zero. Figure 2 shows the high level amplifier with the DC Servo Control circuit in the shaded area enclosed by the broken lines. If a DC drift appears at the amplifier output, the Servo Control system operates to vary the bias of Q3 and Q9, the constant current loads of the input FET buffer devices Q1a and Q1b, to prevent DC drift and keep the output at "0" potential at all times.

The DC Servo Control system makes output DC blocking capacitors unnecessary so that coupling capacitors are completely absent from the TUNER and AUX inputs to the final output. At the same time, the output impedance is held to a very low two ohms over the entire bandwidth which prevents the effects from the capacitance of the shield cord.

Q5a and Q5b comprise the Cgd Cancelling Circuit which is similar in operation and function to the Cgd Cancelling Circuit in the equalizer amplifier.

## 6 FULL-FLEDGED CLASS-A SYMMETRICAL, PUSH-PULL DIRECT COUPLED HEADPHONE AMP

This Control Center has a full-fledged, Class-A symmetrical, push-pull, exclusive headphone amplifier that permits headphone use, not only for monitoring, but for checking the sound quality of program sources.

## 7 NEWLY DEVELOPED NOISELESS VOLUME CONTROL

The Volume Control is probably used more than any other control in a Control Center amplifier. Therefore, it must not only be durable, but its movable sliders and resistive element must have minimum contact resistance from a sound quality viewpoint.

The volume control of the C-240 perfectly fills this need. It employs 18 brush-like sliders and a new conductive plastic resistive element with a hard, glassy surface. The latter is a one piece mold made by molding together a series of resistive elements with thermoset resin insulation and conductive particles.

This conductive plastic resistive element and the 18 brush-like sliders have reduced contact resistance by more than 18 times comparing to the ordinary one, and made possible an outstanding volume control that ensures highest stability and durability.

## 8 HF TRIMMING KNOB PERMITS ADJUSTMENT OF PHONO CARTRIDGE CHARACTERISTICS

Resonance peaks are created in the high frequency range of some magnetic cartridges by the resonance of its moving elements, its coil inductance and the stray capacitances of its wiring. Sometimes these characteristics are welcomed for the distinctive sounds that is exclusively reproduced by that cartridge, but more often they have a negative effect on sound performance.

A HF Trimming control is provided which permits adjustment of such high frequency cartridge peaks and allows continuously variable fine adjustments from Flat position to -80dB (at 20 kHz). This HF Trimming control has no effect on other program sources.

## 9 8-STEP TONE CONTROL WITH TURNOVER FREQUENCY SELECTION

Choice of Tone Control Turnover frequencies is offered at 500Hz and 200Hz in the low frequency range and at 2kHz and 7kHz for the higher frequencies. Use of the 200Hz and 7kHz turnover frequencies offers fine tone adjustments on the lowest bass and the highest treble tones. Variations are in 2dB steps.

## 10 THREE-STEP LOUDNESS COMPENSATION

A three-step loudness compensation system permits energy balance adjustments at low listening levels and offers a choice of three compensation characteristic curves to accommodate different listening levels and room acoustic conditions. COMP 1 provides +6dB compensa-

tion at 50Hz, COMP 2: +9dB at 50Hz, and COMP 3: +10dB at 50Hz and also +6dB at 20 kHz.

## 11 SUBSONIC FILTER

Since design priority was placed on practicality, only a 17Hz 12dB/oct Subsonic Filter was made available. It is an active filter formed by adding CR (capacitance and resistance) components to Q1A, the active device at the input of the high level amplifier. Since an exclusive active device was not employed, sound quality and S/N ratio are not affected.

## 12 COMPLETE TAPE RECORDER FUNCTIONS

Two tape recorders can be connected. An independent copy switch is provided which permits tape copying from one machine to the other, and at the same time listening to a different program source. The output for the tape recording can be cut off by an independent switch as occasion demands. This switch also effectively prevents distortion that may otherwise be caused when the AC power of the tape recorder is at off, and the input circuit of the tape machine poses a load to the control center.

## 13 CONVENIENT ATTENUATOR SYSTEM

A very convenient attenuator lever switch for use when starting off or changing records is available. In addition push switches provide a choice of three attenuation levels of -10dB, -20dB and -30dB.

## 14 MODE SWITCH INCORPORATES BLEND PROVISION

Besides STEREO, REVERSE and MONO, the MODE switching system also offers the choice of a BLEND position. It is very useful in correcting the unnaturalness of sound that may be caused by excessive separation in the program source, or when the distance between the speakers is too great. This position narrows left-right channel separation by 10dB for a more natural reproduction in such cases.

## 15 XLR TYPE OUTPUT CONNECTOR

Three output connectors are provided. One of these is an XLR (Cannon) Connector type which is most suitable for making tight, reliable connections in professional applications.

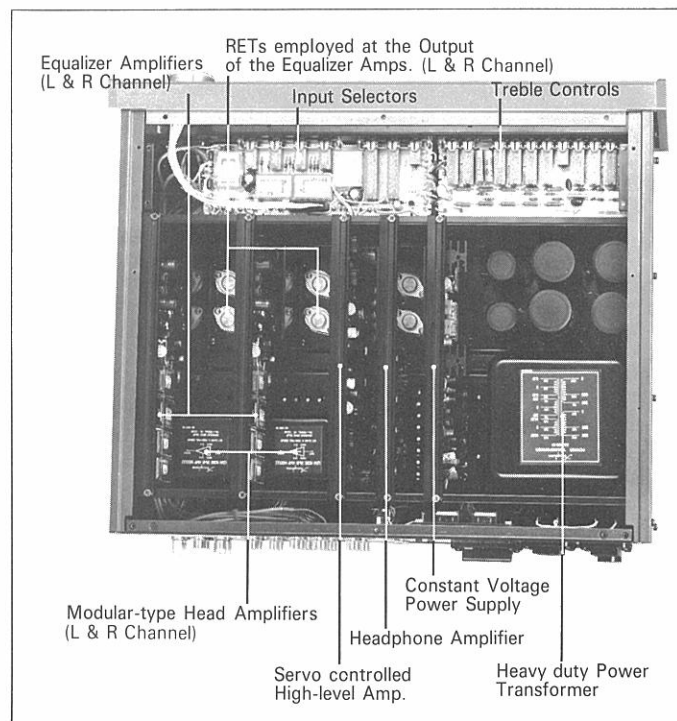

# Accuphase C-240

PRECISION CONTROL CENTER

## GUARANTY SPECIFICATIONS

### PERFORMANCE GUARANTY:

All Accuphase product specifications are guaranteed as stated.

**FREQUENCY RESPONSE:** High-level Input: +0, -0.2dB 20Hz to 20,000Hz  
 Low-level Input: +0.2, -0.2dB 20Hz to 20,000Hz

**DISTORTION:** Lower than 0.005% at rated output level, 20Hz to 20,000Hz

### INPUT SENSITIVITY AND IMPEDANCE:

DISC 1/DISC 2 (without HEAD AMP): 2.0mV, Selector for 100-ohm; 47k-ohm, 82k-ohm, 150k-ohm  
 DISC 1/DISC 2 (with HEAD AMP): 0.1mV, 100-ohm fixed  
 TUNER: 126mV, 50k-ohm  
 AUX: 126mV, 50k-ohm  
 TAPE PLAY 1/TAPE PLAY 2: 126mV, 50k-ohm

### OUTPUT LEVEL AND IMPEDANCE:

OUTPUTS: 2.0V\*, 2-ohm  
 TAPE REC 1/TAPE REC 2: 126mV, 500-ohm (\*at rated input level, volume control maximum)

### HEADPHONES: OUTPUT IMPEDANCE: 0.3-ohm

OUTPUT POWER: 0.25W (8-ohm load) at 1kHz, 0.01% distortion  
 (at rated input level, volume control maximum)

**MAXIMUM OUTPUT LEVEL:** 10 Volts at 0.005% distortion, 20Hz to 20,000Hz

### MAXIMUM INPUT FOR DISC INPUT:

DISC 1/DISC 2 (without HEAD AMP): 400mV RMS for 1 kHz at 0.005% distortion  
 DISC 1/DISC 2 (with HEAD AMP): 20mV RMS for 1 kHz at 0.005% distortion

**OUTPUT LOAD IMPEDANCE:** OUTPUTS: 1k-ohm minimum  
 TAPE REC: 10k-ohm minimum

### VOLTAGE AMPLIFICATION IN DECIBELS:

TUNER, AUX, TAPE PLAY input: to TAPE REC; 0dB  
 to OUTPUTS; 24dB  
 to HEADPHONES; 20dB

DISC input: to TAPE REC; 36dB/62dB\*  
 to OUTPUTS; 60dB/86dB\*  
 to HEADPHONES; 56dB/82dB\* (\*HEAD AMP switch set to ON)

### HUM AND NOISE: (at rated input)

High-level Input: 110dB below rated output, IHF-A weighted  
 Low-level Input (without HEAD AMP): 85dB below rated output, IHF-A weighted  
 Low-level Input (with HEAD AMP): 72dB below rated output, IHF-A weighted

### TONE CONTROLS:

8-step Push-button Switch for both channels with turnover frequency switches and DEFEAT switches.  
 Tone is varied in 2dB steps.

BASS; Turnover Frequency 500Hz; ±8dB at 50Hz  
 200Hz; ±8dB at 20Hz  
 TREBLE; Turnover Frequency 2,000Hz; ±8dB at 20kHz  
 7,000Hz; ±8dB at 50kHz

### LOUDNESS COMPENSATOR: (Volume Attenuation at -30dB)

COMP 1; +6dB at 50Hz  
 COMP 2; +9dB at 50Hz  
 COMP 3; +10dB at 50Hz, +6dB at 20kHz

**DISC HIGH TRIMMING:** Continuously variable for each input from 0dB (FLAT) to -8dB at 20kHz.

**ATTENUATOR:** -10dB; -20dB and -30dB variable

**SUBSONIC FILTER:** 17Hz cutoff 12dB/oct.

**SEMICONDUCTOR COMPLEMENT:** 159 Tr's, 10 FET's, 102 Di's

**POWER REQUIREMENT:** Voltage Selector for 100, 117, 220, 240V 50/60Hz operation  
 Consumption; 80 watts

**DIMENSIONS:** 445 mm (17-1/2 inches) wide,  
 160 mm (6-5/16 inches) max. high  
 370 mm (14-9/16 inches) deep

**WEIGHT:** 15 kgs. (33 lbs.) net, 19 kgs. (41.8 lbs.) in shipping carton

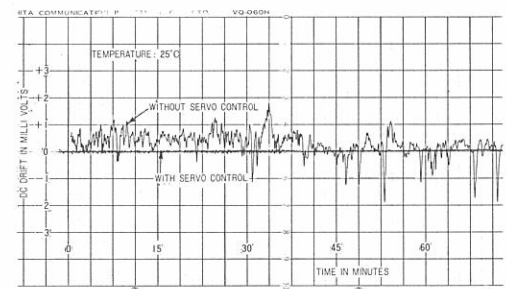
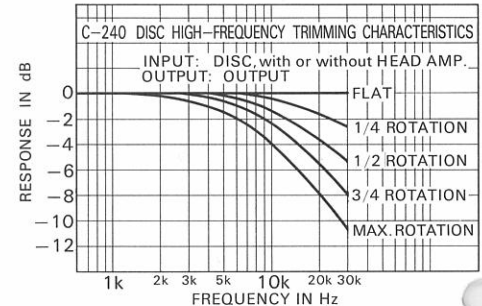
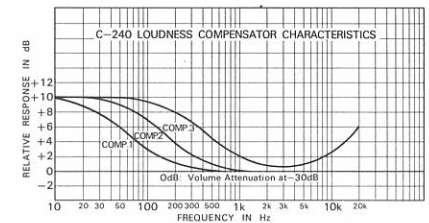
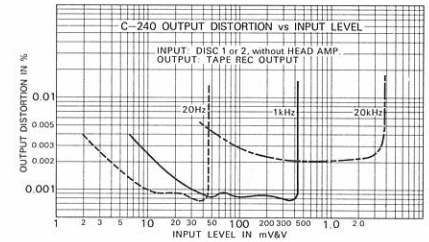
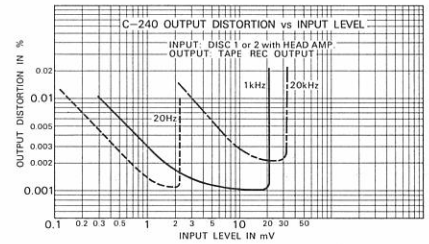

DC DRIFT OF HIGH-LEVEL AMPLIFIER  
 WITH SERVO CONTROL VERSUS WITHOUT  
 SERVO CONTROL

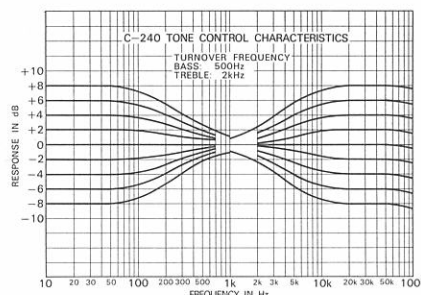
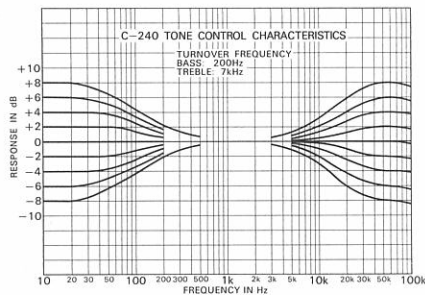

**Accuphase**  
 KENSONIC LABORATORY INC.